

Grange

DEFINING GARDENS

TRADITIONAL PERGOLA

PKTRADA - 279.8cm [H] x 270cm [W] x 270cm [D]



Self-Assembly required



Home Delivery available

PLAN

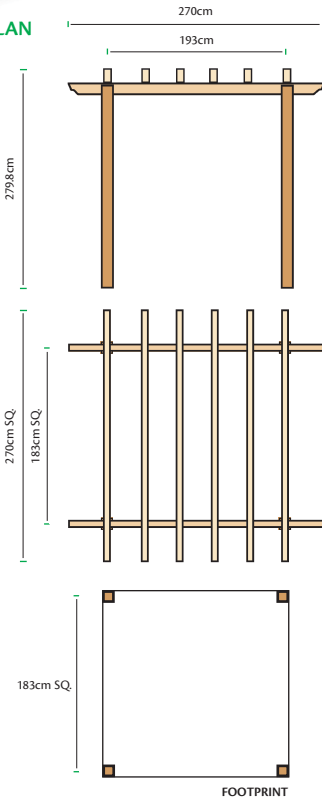

5 019063 601739 >

CODE:PKTRADA

©2016 Grange Fencing Ltd
All rights reserved.

In line with the Company's policy of continuous product development, the right is reserved to change and improve product design without prior notice.
All products and related emblems featured are trademarks of Grange Fencing Ltd.

www.grangefen.co.uk



ASSEMBLY INSTRUCTIONS

TRADITIONAL PERGOLA

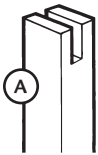

PRESSURE TREATED GREEN



PARTS LIST

(A) Posts [ATPOST9]	x 4
(B) Rafters	x 8

HARDWARE PACK

	[x] Screws - 5mm x 7cm	x 8
	[y] Screws - 4mm x 4cm	x48
	[z] Metal Brackets	x12

BEFORE YOU START

- Check the pack/s and make sure that you have all of the parts listed above. If not, contact your retailer who will be able to help you.
- When you are ready to start, make sure you have the right tools to hand, plenty of space and a clean, dry area for assembly. It is advisable for two people to carry out the work

SITE PREPARATION

Excavate a 30cm square hole (approx) for each post to a depth of at least 30cm. (see Fig.A right)

This will give your structure adequate stability.

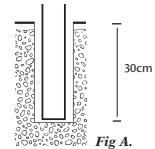

ASSEMBLY

1. The Structure is spaced to allow standard Grange panels to be inserted, if preferred, to provide a screen. The distance between each of the posts is therefore 183cm (see Fig.1)
2. It is advisable to mark each of the Rafters (B), used as supports, where the roof rafters will be fixed, before beginning assembly. For the suggested spacing see Fig.2.
3. Decide on the orientation of the structure.
4. Position two of the Posts (A) to enable one of the Rafters, previously marked, to be fitted. Ensure the distance between the two Posts is set at 183cm before fixing the rafter in position with screws (x).
5. Repeat step 4 for the second pair of Posts.
6. Using one of the remaining Rafters, fix it at one of the end points on one of the assemblies, using the Metal Brackets (z) as Fig.3.
7. Then fix the other end of the Rafter to the other assembly at the corresponding point.
8. Repeat steps 6 & 7 at the opposite end of the structure so that it is able to stand upright. Ensure it is level and upright by adjusting posts.
9. When this has been carried out, the remaining Rafters may be fixed using the Metal Brackets at the positions previously marked.
10. Re-check that the structure is level and upright. (see Fig.4) before fixing the posts permanently.

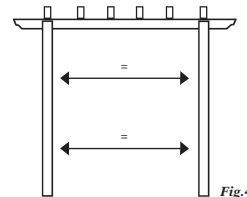
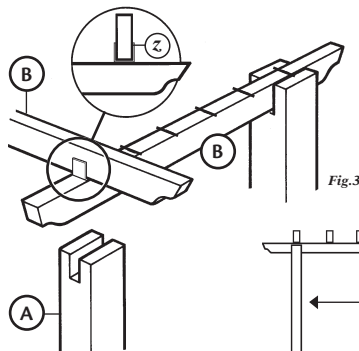
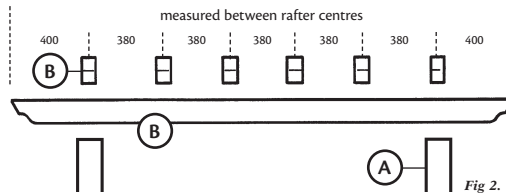

AFTERCARE

To ensure longevity of your structure it is recommended that it is treated with a wood preservative on a yearly basis.

Tools Required: Posidrive Screwdriver